

Using The Guidance Information

Prior to any ClickSmart installation we recommend both the guidance information and installation instructions are read thoroughly to help prevent potential issues arising during installation, programming and operation.

1 Training

We recommend all installers attend the free training course to get a better understanding of the ClickSmart Controls, including how each component works, how it's installed and how its programmed.

Interested in attending the free training course? Visit the dedicated ClickSmart website www.click-smart.com and complete the contact sheet.

2 Signal Range Testing

Prior to installation we recommend that a signal range test is carried out between the location of the transmitter and receiver and repeater (if required) to establish if the operation is within range.

Signal range testing can be carried out as follows:





- a. Basic Testing - Use the keyfob (RF KEY) and plug in socket (RFSC-61)
This will give an idea of potential signal issues.
- b. Advanced Testing - Using the RF Pilot (RF PILOT) and/or RF Touch (RFT-WBK/MWH) and plug-in socket (RFSC-61) will show the signal range as a percentage. We recommend repeating the test 3 to 5 times with taking the average. If less than 40% may result in intermittent or limited control.
- c. If you know which transmitters and receivers are required, use the transmitter and receiver with the shortest signal range to carry out the initial testing.

If the RFIM-40B (universal input transmitter) is a requirement, we recommend fitting the switch plate and transmitter on to a metal wiring accessory back box for testing if this is how it will be installed.

3 Signal Transmission Through Materials

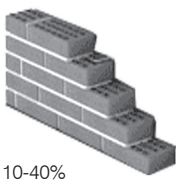
Care should be taken with regards to the location of transmitters and receivers as transmission of the signal differs through different materials.

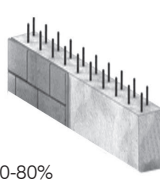
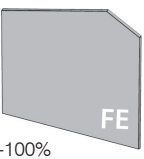
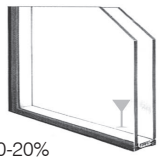
The table below gives an indication of the percentage of signal loss through each material.

 10-40%	 5-20%	 40-80%	 90-100%	 10-20%	
Brick Walls	Wooden Contructions With Plaster Board	Reinforced Concrete	Sheet Metal	Regular Glass	

Signal range testing is crucial as modern building materials can contain aluminium lined plasterboard, aluminium lined polystyrene insulation and energy saving glass with a metal oxide coating.

Internal furnishings can also affect the signal, e.g. mirror (metal backed), metal framed furniture, glass furniture etc. This ideally needs to be explained to the customer to prevent future potential issues arising.

Signal Repeater (RFRP-20B): The repeater allows the installer to overcome building material issues with offsetting the repeater to bypass the material.

4 Documenting The Installation

No matter how small the install, we always recommend making a note of the receiver model along with the hexadecimal address (alpha or numeric or both). In the future event the system is to be expanded will remove the issue of having to gather the information from previously installed items.

Installation sheets are available for download from the www.click-smart.com website. See the RF Pilot or RF Touch for the PDF download.

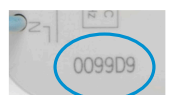

5 Installation Of Receivers

When installing the 50mm x 50mm box receivers, the antenna is located towards the top of the module. When installing individually the receiver should normally receive the transmitter signal from all angles (dependant on surrounding materials).

When installing multiple receivers in the same *non-metallic* enclosure, the following installation guidelines are recommended:

1. Both box and DIN rail mountable receivers require a distance of >30mm between each module.

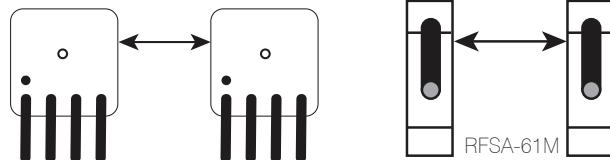

2. Box receivers, stagger each one. So one towards the back and the next towards the front. This helps the signal to reach the required receiver if controlled from the side.

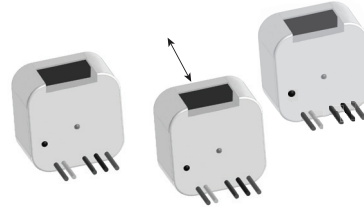

Contactors - When using with receivers

The recommended distance from a contactor to a receiver or a transmitter is greater than 1 metre. This is due to the electromagnetic field (EMF) created when the contacts engage in the contactor.

Receiver operating randomly

With the receivers manufactured using electronic components, their control can be influenced by electromagnetic fields created by contactors or other electronic devices in local proximity to the receiver. We recommend the distance between the receiver and any device emitting EMF is greater than 1 metre.

6 LED Loads - Installation And Control

The mains input running current of an LED driver is different from the current immediately after the moment of switching on. For this reason the switched contact needs to be rated to withstand the input current (inrush). This is owing to the capacitive nature of their input circuits.

The inrush current can be greater than 10 times the normal running current. This can cause practical problems like contacts welding together (will not turn off) etc.

Potential solutions are:

1. Split the load
2. Install a suitable contactor controlled by the ClickSmart receiver.
3. Install a thermistor to suppress the inrush current

7 Fault Protection

All receivers have an integrated fault mode, this is signified by the receiver's LED permanently flashing.

In the event the receiver is overloaded, controlled constantly over a short timescale by one or more transmitters or there is a wiring issue can lead to the fault mode being triggered.

To return the receiver to normal working mode, the power to the receiver must be isolated and the issue resolved prior to re-energising the power.

If the fault persists and the load being controlled is LED, please refer to section 6 above or if connected to a contactor see section 5 above.

Installation of receiving devices should be carried out by a qualified electrician. Any device with the signs of damage and/or missing parts should NOT be installed and should be returned to the seller. Before attempting installation, ensure all associated circuits and cables have been isolated at the source. Please refer to 'Installation Guidance Notes' supplied before commencing with the installation.

Devices are designed to be mounted internally only.

1 RFDA-71B - 250W Single Channel Dimming Receiver

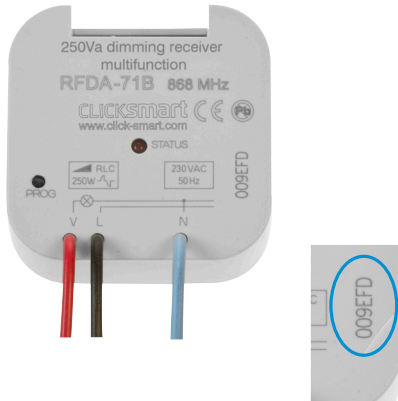

Dimmable load type: Capacitive, Resistive or Inductive

Receivers can be mounted directly behind individual appliances, control circuits locally or within the consumer unit. We recommend the receiver is installed inside a non-metallic enclosure.

Receivers may have the programme button set back in to the housing, this is normal. A thin blunt implement e.g. stylus can be used to press and hold the programming button.

We recommend noting the hexadecimal code printed on each receiver and the appliance it is controlling for potential future use.





The receiver can be controlled by up to 32 transmitting devices

2 Signal Range

The RFDA-71B has a signal range in free air of up to 160 metres.

Once the signal penetrates building materials etc., the signal range will be reduced. See the installation guidance notes supplied with this device.

3 Load Type

Load Types	R	L	C	LED
R - RESISTIVE  HAL. 230V 	250W	250W	250W	25W*
L - INDUCTIVE  HAL. 12-24V 	Incandescent & halogen	12-24V Wound Transformers	12-24V Electronic Transformers	Category 1 & 2 Regulation of the 230V~ input voltage, e.g. GU10, E27 & E14
C - CAPACITIVE 				

* The load may change dependant on lamp or fitting manufacturer.

! Warning Inductive and resistive loads MUST NOT be connected together through one channel

4 Wiring

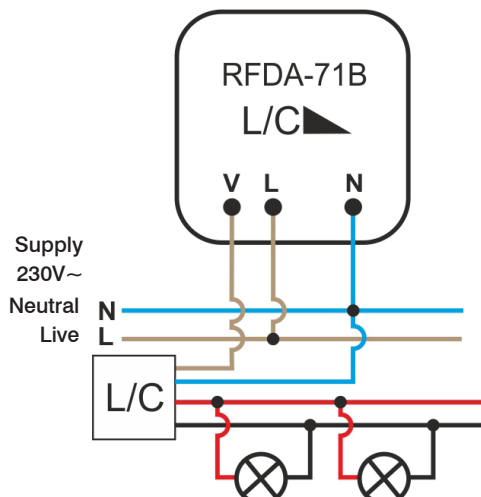
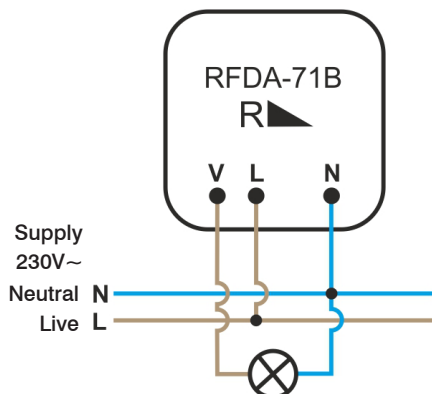

5 Functions (Dimming Receivers)

		Press button and release	Press button and hold
Function 1	Scene recall / OFF	Press to recall scene, press to turn OFF	Press button for more than 1 second to set scene brightness
Function 2	Scene recall / OFF - Anti-tamper	Press to recall scene, press again to turn OFF	Press button for more than 3 seconds to set scene brightness (avoids accidental scene setting)
Function 3	Scene recall - fade ON / fade OFF - Push to recall scene	Press to recall scene	Press button for more than 1 second to set scene brightness
Function 4	Scene recall / fade OFF	Press to recall scene	Press button for more than 1 second to set scene brightness
Function 5	Variable fade up to Max. (Definable 2 seconds to 30 mins)	Press to start fade up time to maximum brightness	N/A
Function 6	Variable fade down to OFF. (Definable 2 seconds to 30 mins)	Press to start fade down to OFF	N/A
Function 7	ON/OFF	Press once for ON, press again for OFF	N/A

Functions 5 & 6 (timed elements) are programmed in real time. If you require 30 minutes you have to wait for the 30 minutes to complete the pairing. To help save time and remove potential frustration on 5+ minute timed elements, we always recommend conducting a few shorter timed elements (e.g. 10 seconds) to ensure both the correct function and the correct timed element are programmed.

6 Programming The Receiver To Button Transmitters

When installing with the RF Pilot or RF Touch, use the dedicated product manuals for programming.

STEP 1 - Programming Mode

Press & hold the 'programming' button on the receiver for 2 seconds (*the status LED will flash with a 1 second interval*).

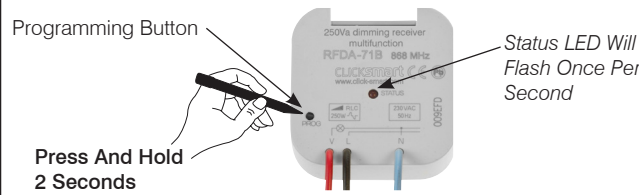

The programme button is recessed in to the body, this is standard. A small implement e.g. stylus can be used to press and hold the button.

STEP 2 - Select Function

To assign the required transmitter button & function, press the required button the number of times to match the function number (e.g. function 2, press the button 2 times).

Press the transmitter button at one second intervals - See table of functions above.

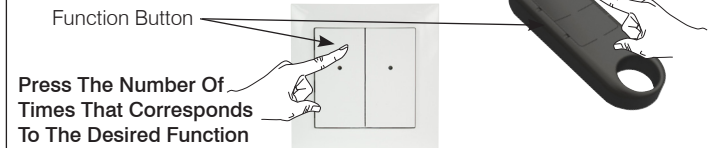

Each time the transmitter button is pressed the LED on the receiver will also flash to confirm the signal has been received.

STEP 3 - Only Required For Functions 5 & 6 (Time Elements) For All Other Functions Go To STEP 4

To set the time element, whilst still in programming mode, press & hold the 'programming' button again for '5 seconds' (the status LED will flash twice a second). **THE TIMER HAS NOW STARTED.**

When the required time period has elapsed, to stop the timer press the assigned transmitter button (IN STEP 2) once.

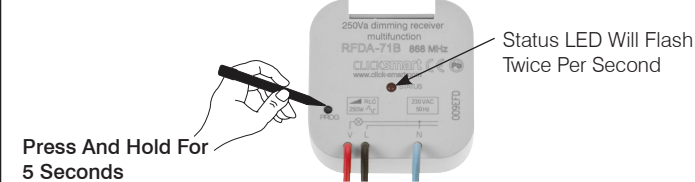

STEP 4 - Save & Exit

To exit programming mode press the 'programming' button for less than 1 second.

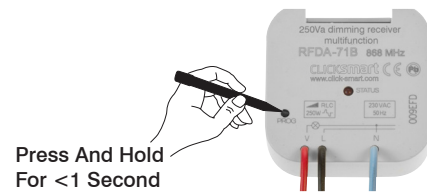

To Remove A Single Transmitter Button From The Receiver

STAGE 1

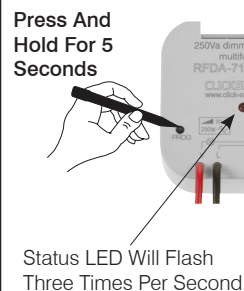

STAGE 2

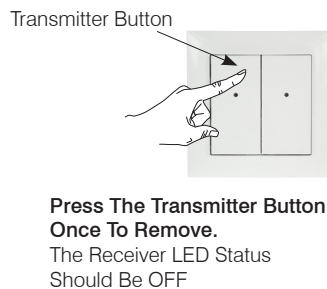

To Remove All Paired Buttons

Press And Hold The 'Programming' Button For Longer Than 8 Seconds.

The LED status will change over the 8 seconds. After 2 seconds the LED will flash once per second. After 5 seconds the LED will flash three times per second and after 8 seconds will go back to flashing once per second, release the programming button.

Press the programme button for less than 1 second to exit programming mode and remove all paired buttons.

